

Dual Diode Power Modules are designed for use in power electronic circuits and equipment under normal operating conditions.

KEY PARAMETERS

U_{RRM} up to **1800 V**
I_{F(AV)} **660 A**
I_{FSM} **18000 A**



Outline

See package details for further information

APPLICATION

- High Voltage Power Supplies
- Motor Control
- Battery Chargers
- Resistance Welding

FEATURES

- electrically isolated base
- high current capabilities
- high surge current capabilities
- high rates voltages
- low thermal impedance (Aluminium Nitride Insulators)
- tested according to IEC standards
- compact size and small weight

Designed for use in high power industrial and commercial power electronic circuits and equipment where high currents are encountered and high reliability is essential.

ORDERING INFORMATION

When ordering please refer to device code builder presented below.
 Please use the complete part number when ordering, quote or in any future correspondence relating to your order.

MD **-660-**

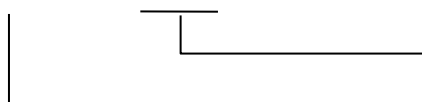

Voltage class (hundred volts)

Elements configuration (see drawings)

ELECTRICAL PARAMETERS

Voltage ratings

Voltage class	U_{RRM}	U_{RSM}	I_{RRM}
	V	V	mA
04	400	500	50
06	600	700	
08	800	900	
10	1000	1100	
12	1200	1300	
14	1400	1500	
16	1600	1700	
18	1800	1900	

Electrical properties

Parameter	Unit	Test conditions	Value
Average forward current @ case temperature	$I_{F(AV)}$	A	660
	T_C	°C	100
RMS forward current	$I_{F(RMS)}$	A	1036
Surge current	I_{FSM}	A	$T_j=T_{jmax}$, $U_R=0,8U_{RRM}$, $t_p=10ms$
I^2t – value	I^2t	kA^2s	1620
Forward voltage drop max.	U_{FM}	V	$T_j=25^\circ C$, $I_{FM}=1500A$
Threshold voltage	$U_{F(T0)}$	V	0,60
Slope resistance	r_F	$m\Omega$	0,3
RMS isolation voltage	U_{isol}	V	1 s, circuit to base, all terminals shorted

Termal properties

Parameter	Unit	Test conditions	Value	
Thermal resistance, junction to case per diode/per module	R_{thjc}	°C/W	DC	0,065 / 0,0325
Thermal resistance, case to heatsink per diode/per module	R_{thch}	°C/W		0,02 / 0,01
Operating junction temperature	$T_{jmin} \dots T_{jmax}$	°C		-40...+150
Storage temperature	T_{stg}	°C		-40...+150

Mechanical properties

Parameter	Unit	Value	
Mounting torque (M6)	M1	Nm	6,00 ±15%
Terminal connection torque (M8)	M2	Nm	12,00 ±10%
Weight	M	g	1490

Cofigurations

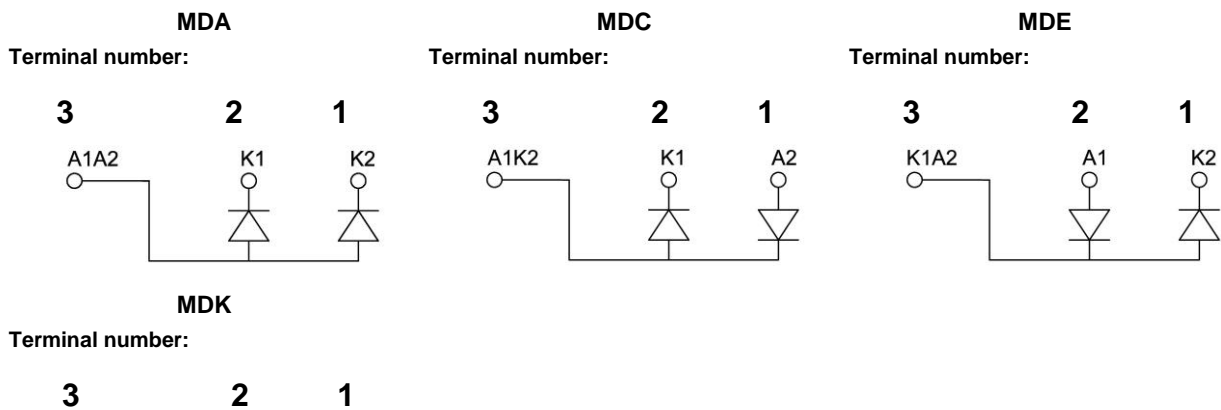

KKMDx660, January 2014 version

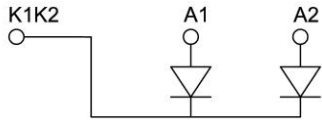

Package details

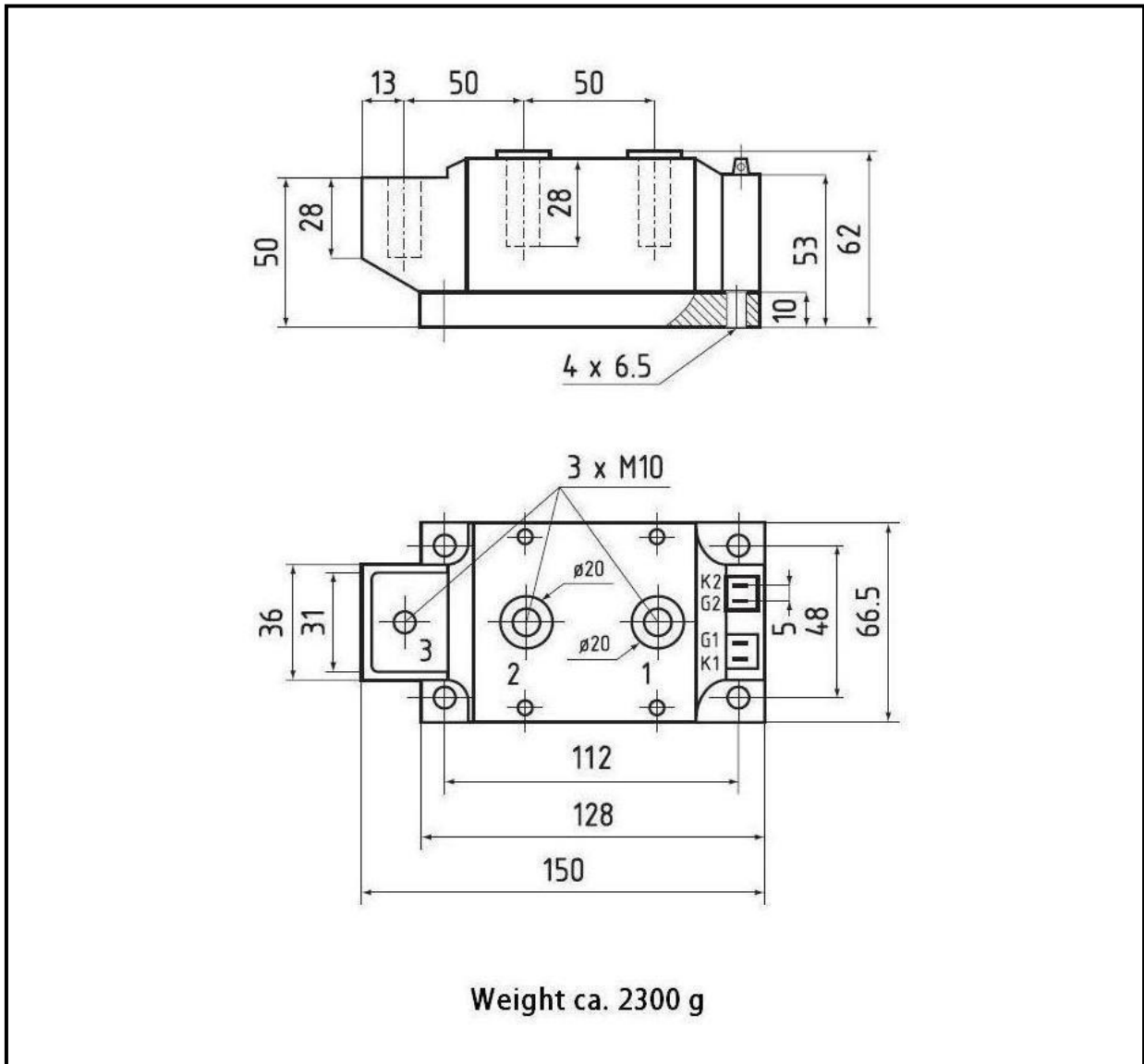

For further package information, please contact Sales & Marketing Department. All dimensions in mm, unless stated otherwise.

Do not scale.

CHARACTERISTICS

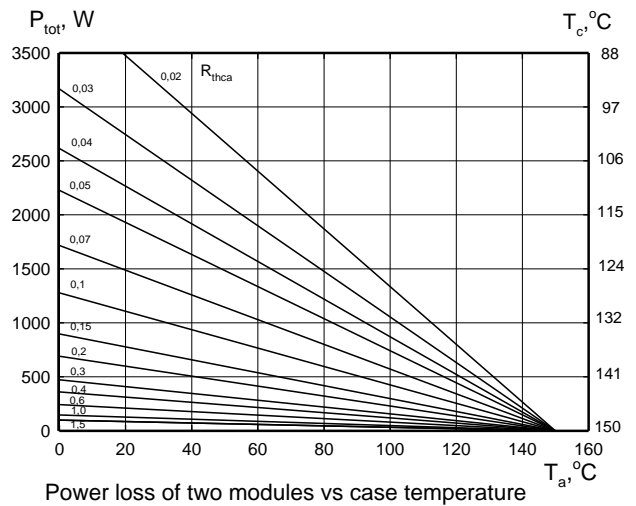
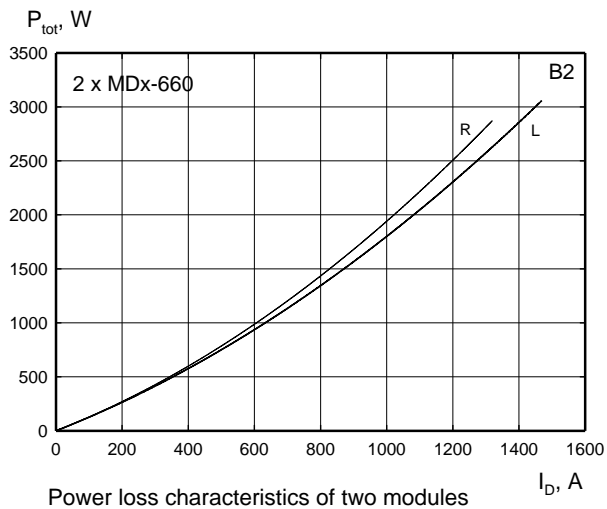
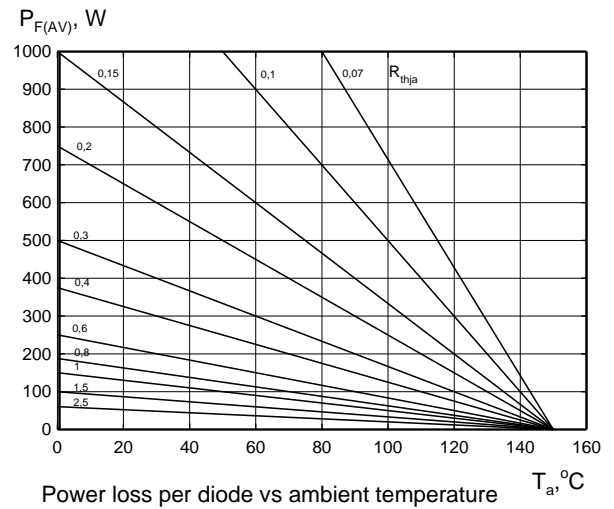
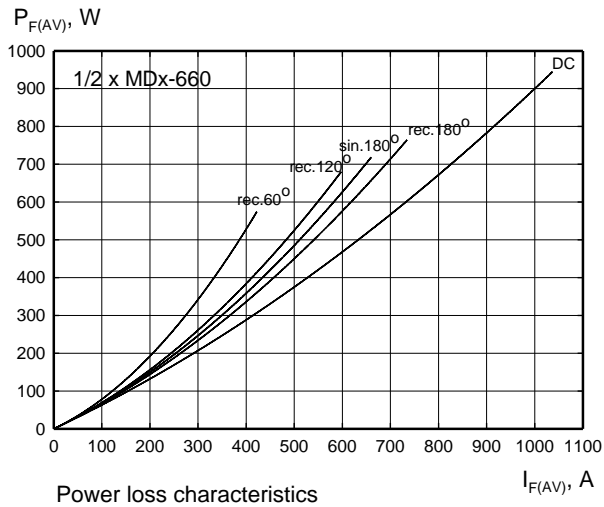

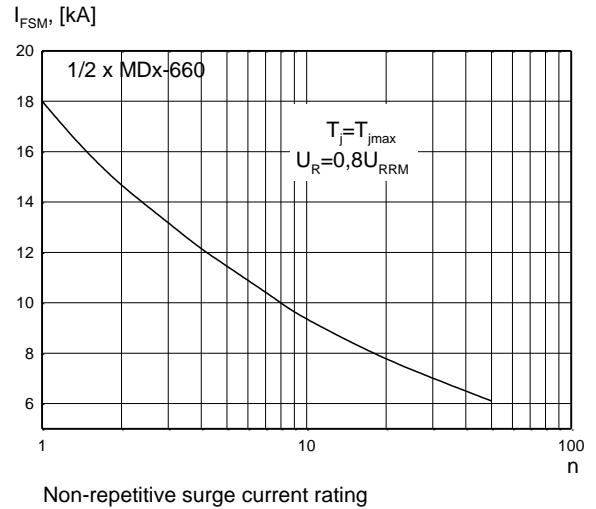
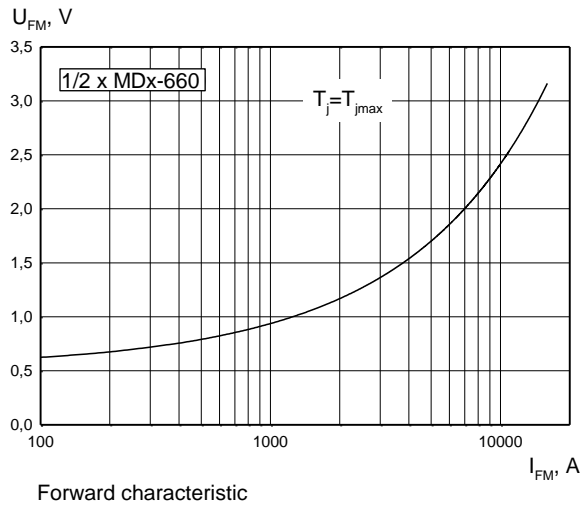
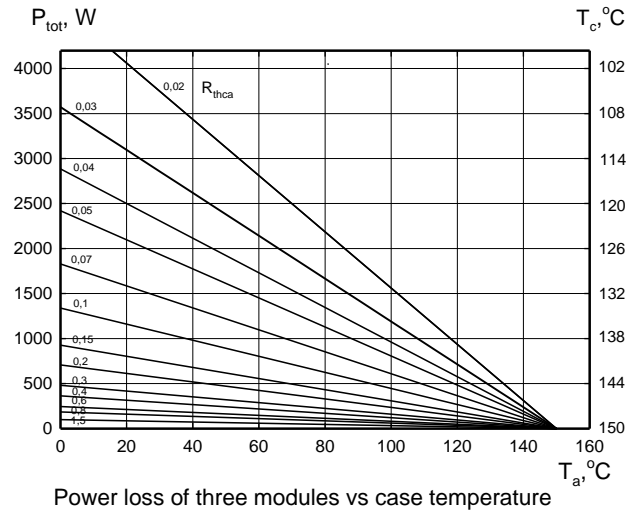
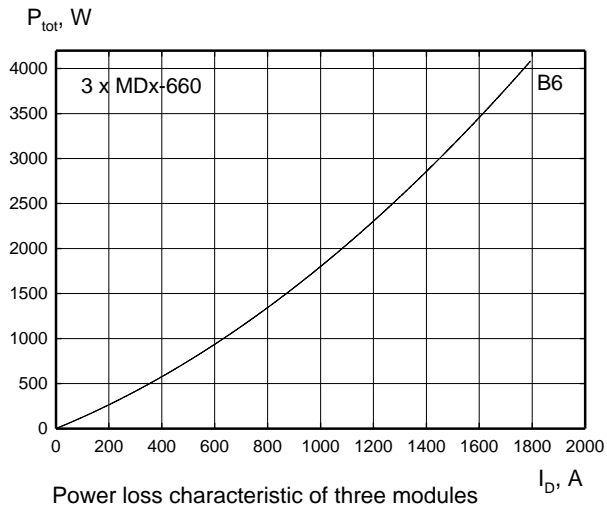

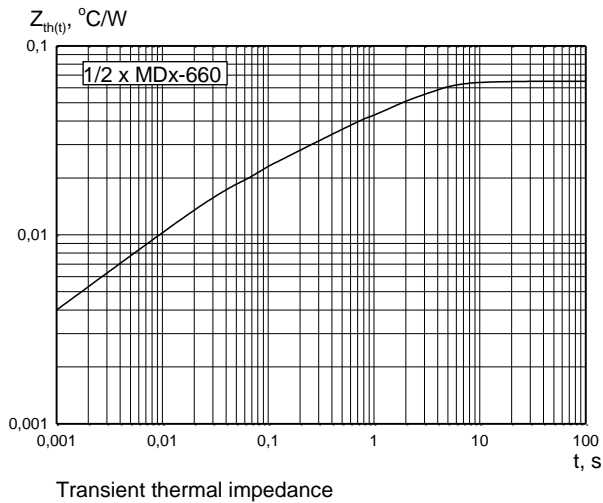

HEATSINKS

KUBARA LAMINA SA has its own proprietary range of extruded aluminium heatsinks designed to optimise the performance of our semiconductors with natural and forced air flow.

POWER ASSEMBLY CAPABILITY

KUBARA LAMINA SA provides a support for those customers requiring more than a basic semiconductor and offers precisely assembled Power Blocks according to factory or customer standards.